



EURO SUPPLY

Leveringsprogramma

MULTITEL

Multitel Algemeen

Eurosupply Hoogwerksystemen BV is exclusief importeur voor deze Italiaanse fabrikant opgericht in 1911 en sinds de jaren 70 autohoogwerkers produceert.

De Multitel autohoogwerkers is een goede keus omdat:

- producten zijn ontwikkeld voor zware toepassingen, met lange levensduur en bijzondere aandacht voor veiligheid
- zeer succesvol met de toepassing van aluminium legeringen in de mastuitvoering
- uitgekiende keuzes voor extra veiligheid, bijvoorbeeld dubbele terugslagkleppen op de stempels, alle cilinders zijn uitgevoerd met pilootgestuurde slangbreuk beveiliging.
- componenten alleen van gerenommeerde fabrikanten met betrouwbare Europese vertegenwoordiging (geen goedkope materialen)
- alle machines door onafhankelijk instituut gekeurd
- gebruik en ontwikkeling van besturing en controle geheel in eigen beheer
- snelle service en onderdelen levering door voorraadbeheer en gebruik standaard componenten



Multitel ALU 145

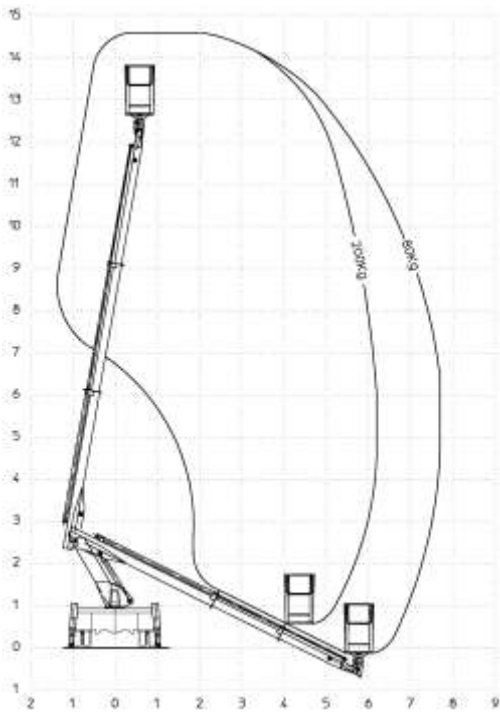
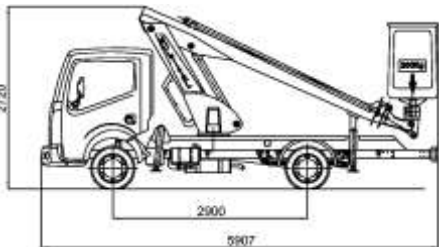

Werkhoogte	14,7 m
Platformhoogte	12,7 m
Reikwijdte 200kg	6,2 m
Reikwijdte 80kg	7,7 m
Stempelbreedte	2,06 m
Zwenkbereik	360°
Afmeting platform	1,20x0,70x1,10 m
platform rotatie	60° + 60°



+31 (0) 168 329331



Multitel ALU 160

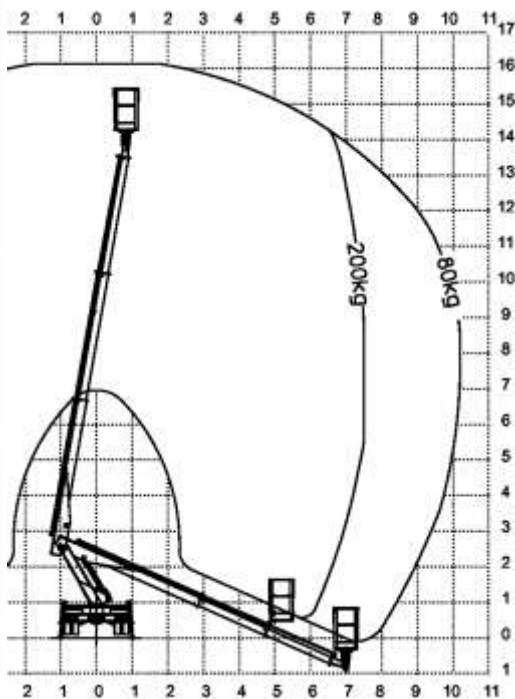

Werkhoogte	16,3 m
Platformhoogte	14,3 m
Reikwijdte 200kg	7,5 m
Reikwijdte 80kg	10,2 m
Stempelbreedte	2,01 m
Zwenkbereik	360°
Afmeting platform	1,60x0,70x1,10 m
platform rotatie	60° + 60°

Multitel 182 DS

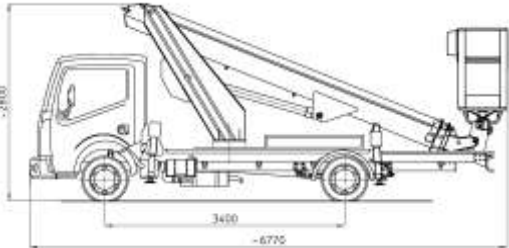
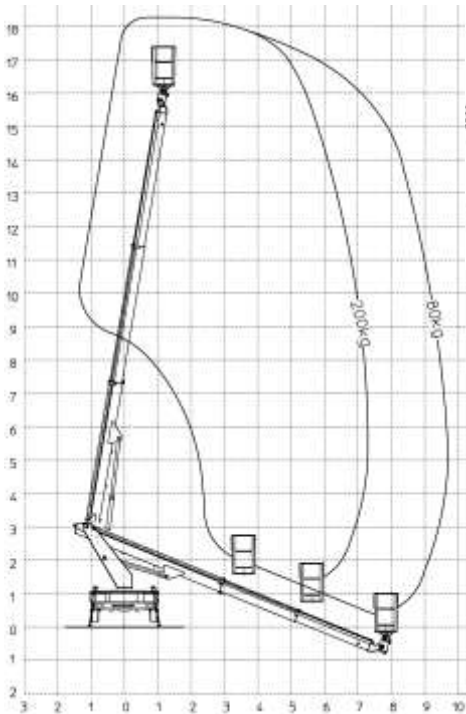

Werkhoogte	18,2 m
Platformhoogte	16,2 m
Reikwijdte 200kg	7,3 m
Reikwijdte 80kg	9,7 m
Stempelbreedte	2,16 m
Zwenkbereik	360°
Afmeting platform	1,20x0,70x1,10 m
platform rotatie	60° + 60°

+31 (0) 168 329331

**EURO
SUPPLY**

Multitel 182 AZ

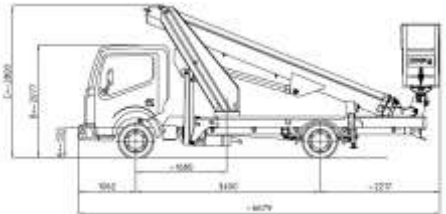
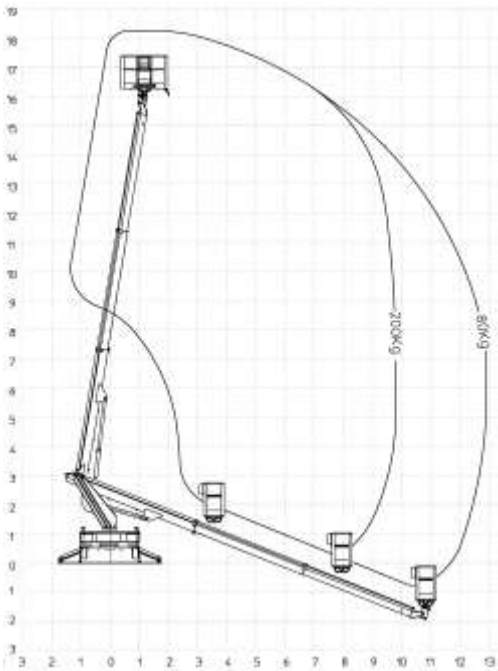

Werkhoogte	18,2 m
Platformhoogte	16,2 m
Reikwijdte 200kg	9,8 m
Reikwijdte 80kg	12,9 m
Stempelbreedte	3,44 m
Zwenkbereik	360°
Afmeting platform	1,60x0,70x1,10 m
platform rotatie	60° + 60°

Multitel 202 DS

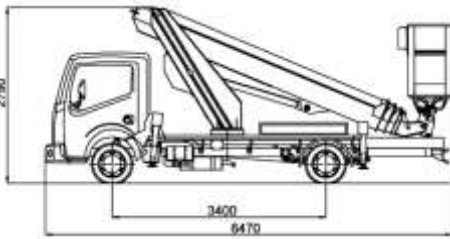
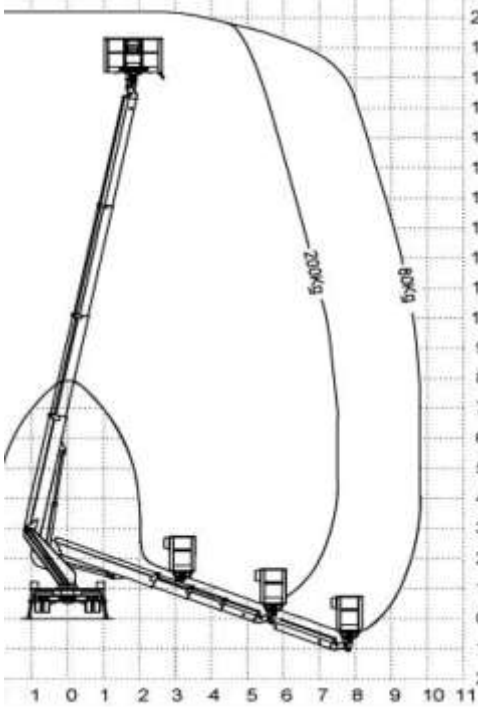

Werkhoogte	20,2 m
Platformhoogte	18,2 m
Reikwijdte 200kg	7,5 m
Reikwijdte 80kg	9,8 m
Stempelbreedte	2,16 m
Zwenkbereik	360°
Afmeting platform	1,60x0,70x1,10 m
platform rotatie	90° + 90°



+31 (0) 168 329331



Multitel 202 AZ

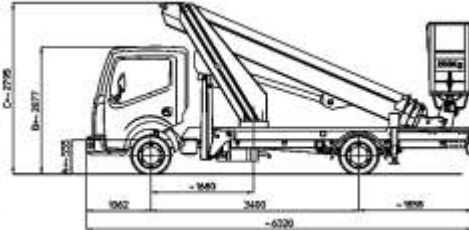
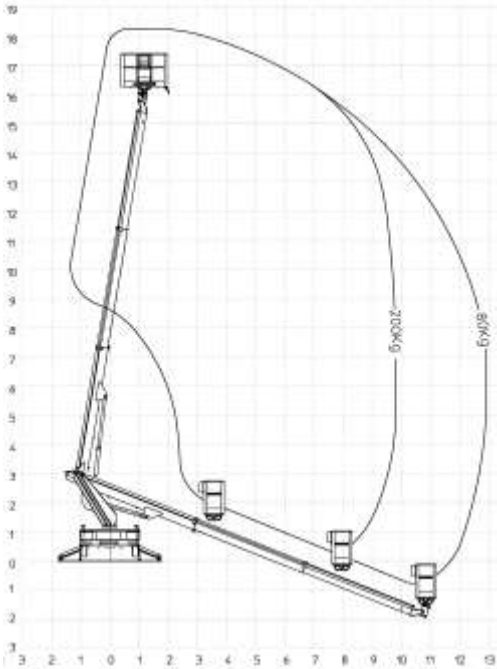

Werkhoogte	20,2 m
Platformhoogte	18,2 m
Reikwijdte 200kg	9,5 m
Reikwijdte 80kg	12,1 m
Stempelbreedte	3,44 m
Zwenkbereik	360°
Afmeting platform	1,60x0,70x1,10 m
platform rotatie	90° + 90°

Multitel 222 AZ

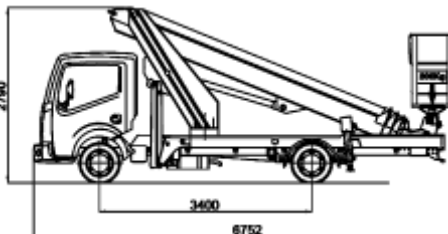
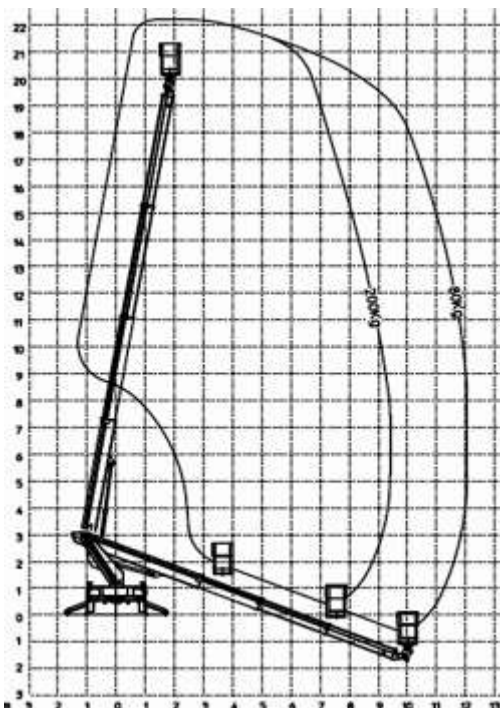

Werkhoogte	22,2 m
Platformhoogte	20,2 m
Reikwijdte 200kg	9,4 m
Reikwijdte 80kg	12,0 m
Stempelbreedte	3,29 m
Zwenkbereik	360°
Afmeting platform	1,60x0,70x1,10 m
platform rotatie	60° + 60°

+31 (0) 168 329331

**EURO
SUPPLY**

Multitel MX 130

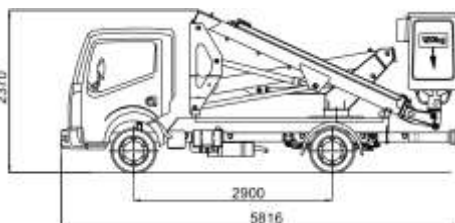
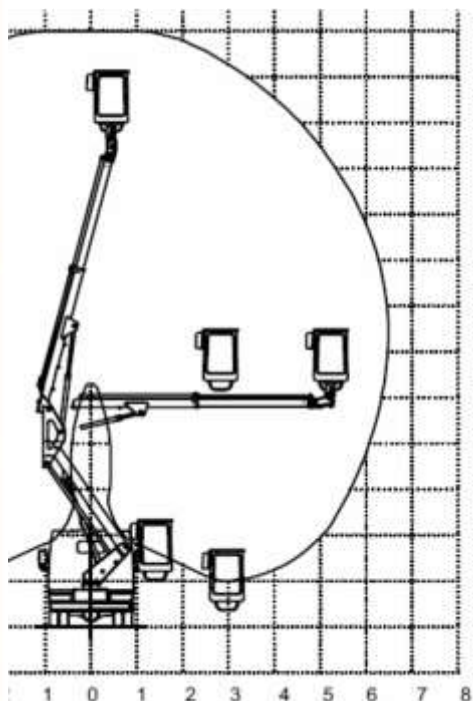

Werkhoogte	13,0 m
Platformhoogte	11,0 m
Reikwijdte 120kg	6,5 m
Stempelbreedte	Geen
Zwenkbereik	360°
Afmeting platform	0,80x0,75x1,10 m
platform rotatie	Geen

Multitel MX 170

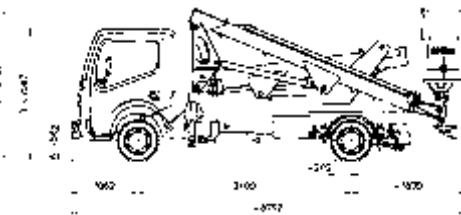
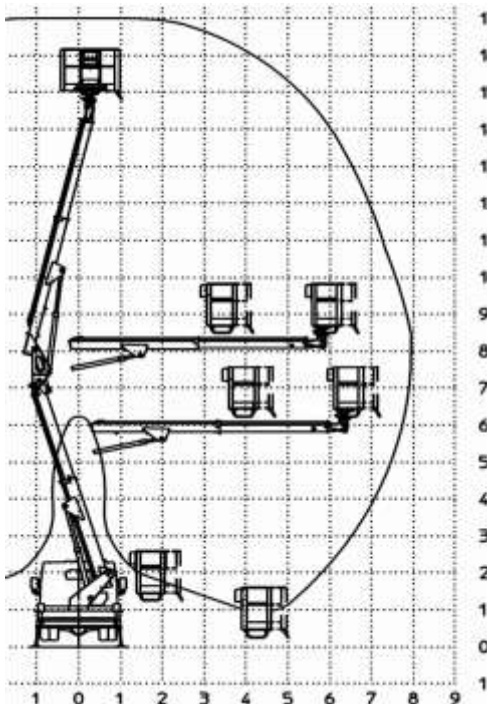

Werkhoogte	17,0 m
Platformhoogte	15,0 m
Reikwijdte 200kg	7,60 m
Stempelbreedte	2,05 m
Zwenkbereik	360°
Afmeting platform	1,40x0,70x1,10 m
platform rotatie	60° + 60°



+31 (0) 168 329331



Multitel MX 200DS

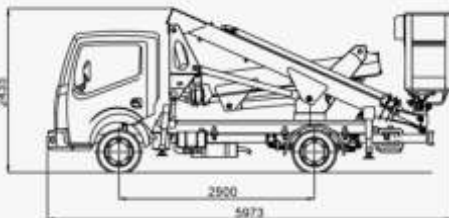
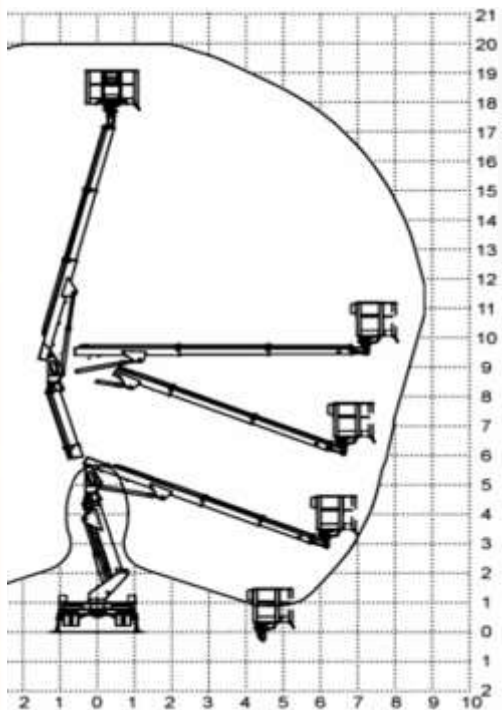

Werkhoogte	20,0 m
Platformhoogte	18,0 m
Reikwijdte 200kg	8,8 m
Stempelbreedte	2,16 m
Zwenkbereik	400°
Afmeting platform	1,40x0,70x1,10
platform rotatie	90° + 90°

Multitel MX 200

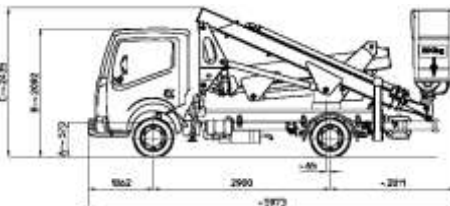
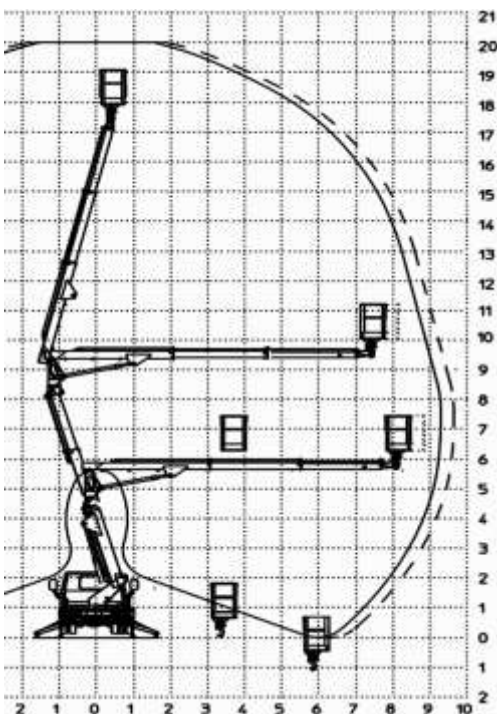

Werkhoogte	20,0 m
Platformhoogte	18,0 m
Reikwijdte 200kg	9,3 / 9,65 m
Stempelbreedte	3,22 m
Zwenkbereik	360°
Afmeting platform	1,40x0,70x1,10 m
platform rotatie	60° + 60°

+31 (0) 168 329331

**EURO
SUPPLY**

Multitel MX 225

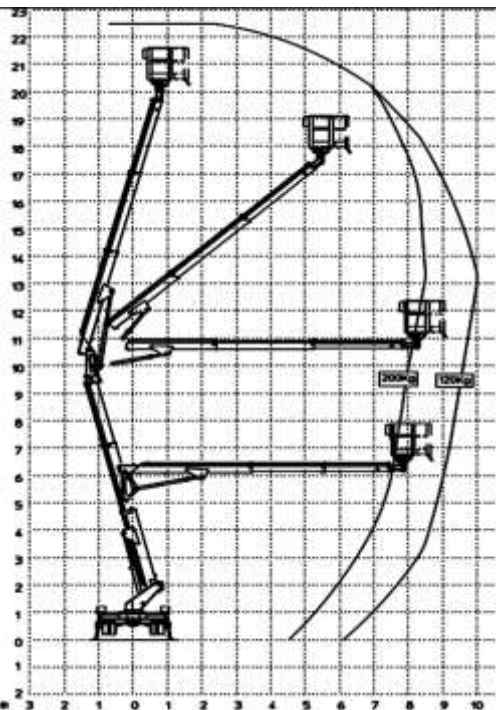

Werkhoogte	22,5 m
Platformhoogte	20,5 m
Reikwijdte 200kg	8,5 m
Reikwijdte 120kg	10,0 m
Stempelbreedte	2,16 m
Zwenkbereik	400°
Afmeting platform	1,60x0,70x1,10 m
platform rotatie	90° + 90°

Multitel MX 270

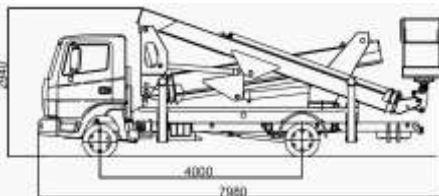
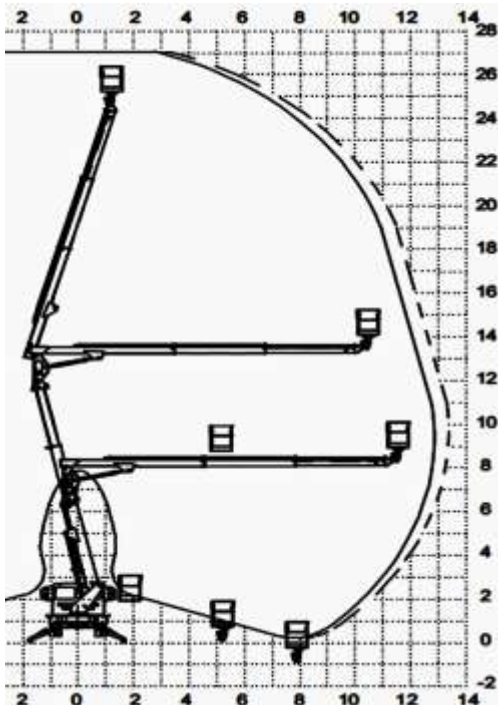

Werkhoogte	27,3 m
Platformhoogte	25,3 m
Reikwijdte 225kg	12,8 m (13,3 m)
Stempelbreedte	3,70 m
Zwenkbereik	360°
Afmeting platform	1,70x0,80x1,10 m
platform rotatie	90° + 90°



+31 (0) 168 329331

**EURO
SUPPLY**

Multitel SMX 170

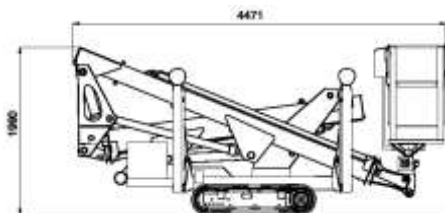
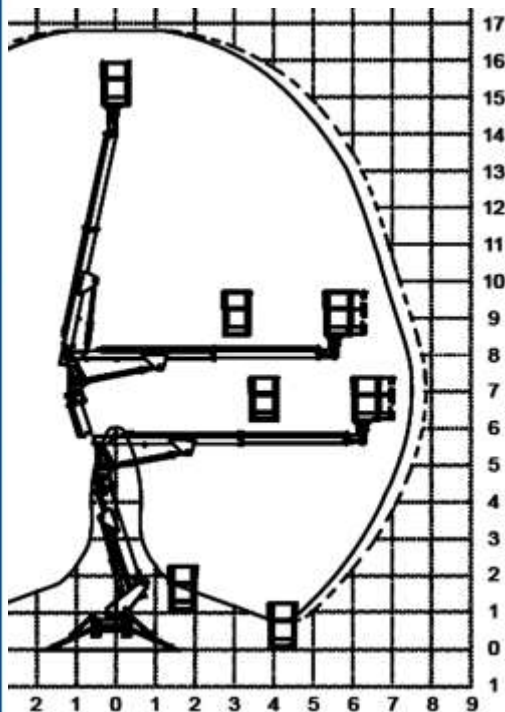

Werkhoogte	16,85 m
Platformhoogte	14,85 m
Reikwijdte 200kg	7,50 m (7,85 m)
Eigen gewicht	2100 kg
Stempelbreedte	3,04 m
Zwenkbereik	360°
Afmeting platform	1,40x0,70x1,10 m
platform rotatie	60° + 60°

Multitel SMX 225

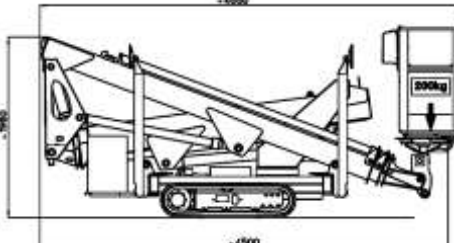
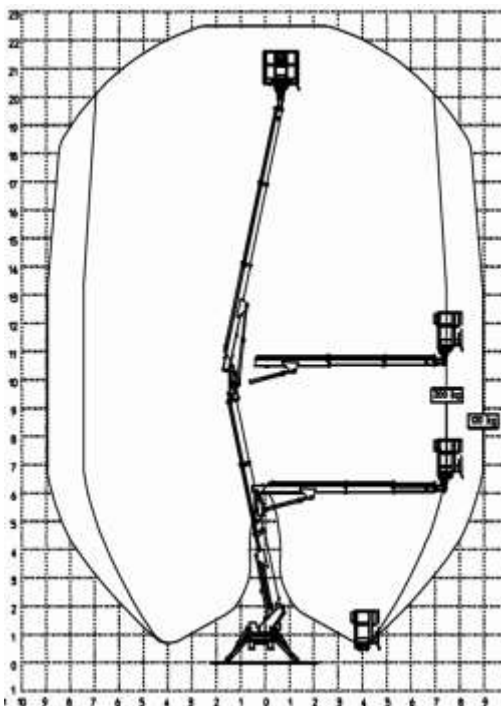

Werkhoogte	22,4 m
Platformhoogte	20,4 m
Reikwijdte 200kg	8,5 m (7,45 m)
Reikwijdte 120kg	10,25 m (8,95 m)
Eigen gewicht	2500 kg
Stempelbreedte	3,4 m (3,0 m)
Zwenkbereik	360°
Afmeting platform	1,40x0,70x1,10
platform rotatie	90° + 90°

+31 (0) 168 329331

**EURO
SUPPLY**

Multitel > 28 m



Type Multitel	Werkhoogte meters	Reikwijdte meters	Hefvermogen kg
Multitel J 328.200 ALU	28,0	18,0	250
Multitel J 335 ALU	35,0	22,5	400
Multitel J 340 TA	40,0	28,0	365
Multitel J 347 TA	47,2	29,5	365
Multitel J 347.600 TA	47,3	29,3	600
Multitel 352 TA	52,0	27,8	365
Multitel J 360 TA	60,0	29,0	400
Multitel J2 365 TA	65,0	33,0	400
Multitel MJ 750	75,0	35,0	600

Over Eurosupply

Eurosupply Hoogwerksystemen BV is in 1990 gestart en heeft zich ontwikkeld tot een totaalaanbieder van hoogwerksystemen in Nederland en België. Door onze jarenlange ervaring, bieden wij het juiste product voor een veilige werkplek op hoogte.

Eurosupply is:

- Importeur van Niftylift, Hitachi, Multitel en Nostolift
- Dealerschap van JLG, Genie en Custers
- Levering in Uw bedrijfskleur, alles is mogelijk
- Verhuur alle typen hoogwerkers
- Cursus veilig werken met de hoogwerker. TÜV en VCA erkend.
- Eigen onderhoudsdienst door geheel Nederland
- Alle hoogwerkers met CE keurmerk.
- Eigen magazijn met alle gangbare onderdelen, dus snelle levering





Bezoekadres

Eurosupply Hoogwerksystemen BV
Oostelijke Randweg 16
4782 PZ MOERDIJK
Havennr. M049
Nederland

T : +31 (0)168 329331

F : +31 (0)168 327730

E : info@eurosupply.net

W : www.eurosupply.net

Postadres:

POSTBUS 68
4780 AB MOERDIJK
Nederland



www.eurosupply.net